

CARAVANES PLIANTES

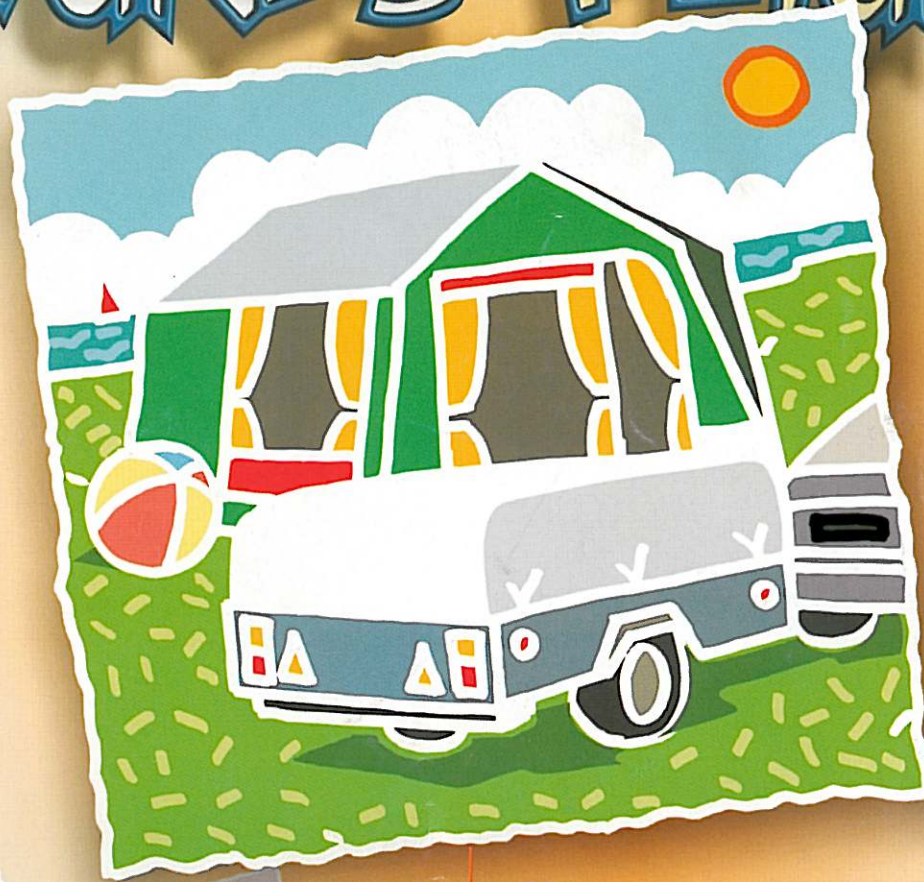

Caravanes pliantes toile
Trailer tents
Vouwwagens
Zeltanhänger
Remolques de campaña
Carrelli tenda tela

R[®]
RACLET
2003



200 Kg

Poids à vide
Weight (excl. baggage)
Eigengewicht
Leergewicht
P.A.V
Peso proprio

450 Kg

Poids total en charge
Maximum loaded weight
Max. toelaatbaar gewicht
Max. Gesamtgewicht
P.A.P.C.
Peso total

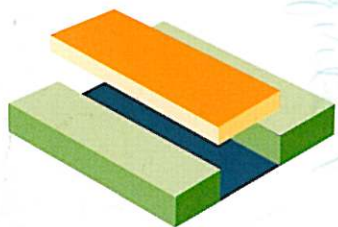

432 L

267 L

82 L



MINTO®

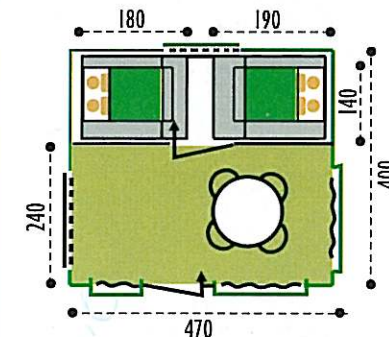
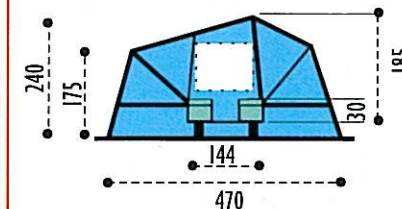
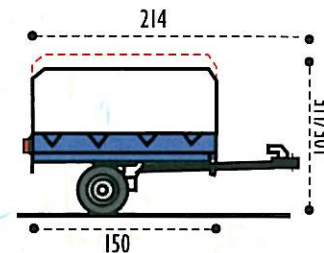



3



RACLET

Caravanes Pliantes

310 Kg / 340 Kg

Poids à vide
Weight (excl. bagage)
Eigengewicht
Leergewicht
P.A.V.
Peso proprio

495 Kg - 650 Kg (NL)

Poids total en charge
Maximum loaded weight
Max. toelaatbaar gewicht
Max. Gesamtgewicht
P.A.P.C.
Peso total

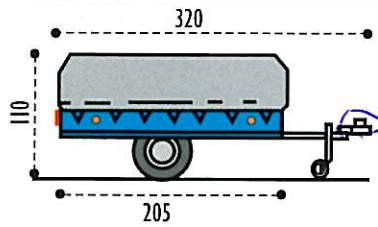
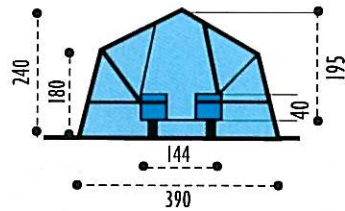

290 L



864 L

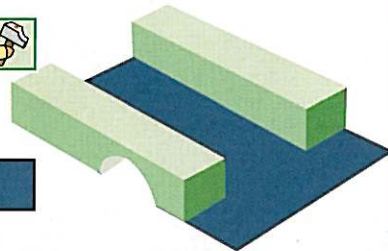

IRIS



Iris 230

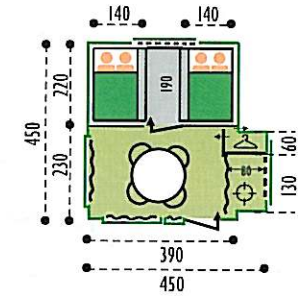

Iris 380

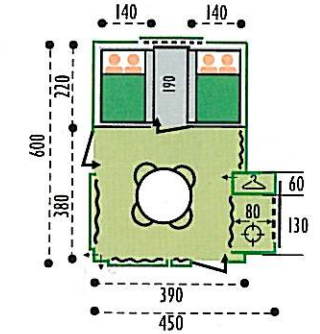

Acropolis

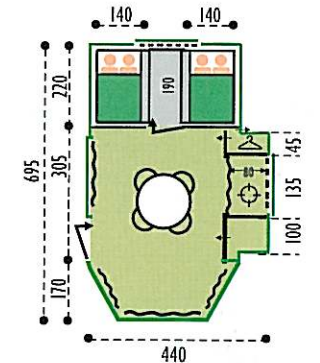

Option
Optie
Nach Wahl
Optional
Opcional
Opzione

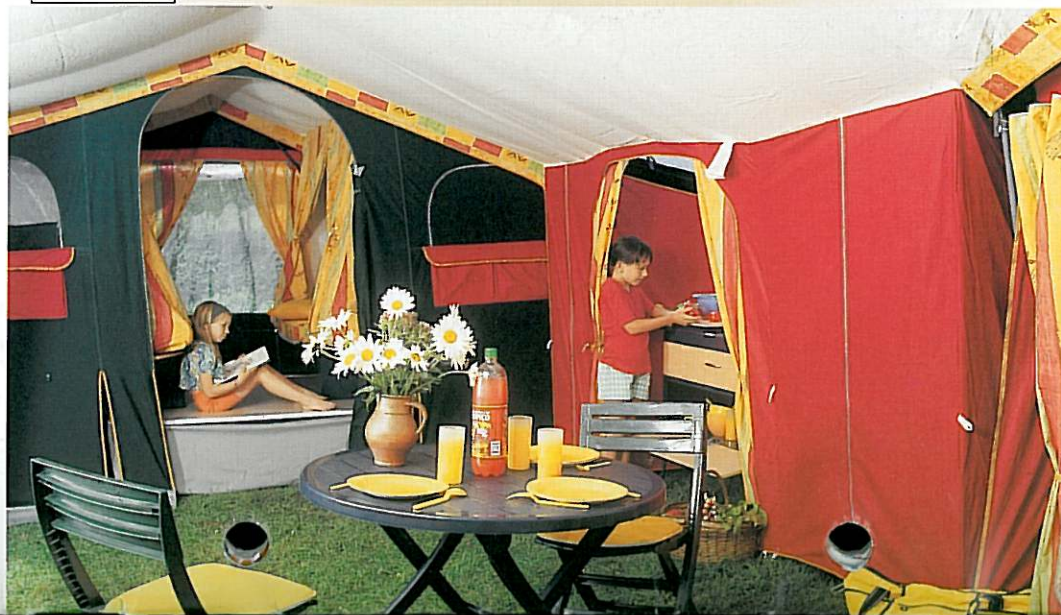

Acropolis

Aeropolis

Iris 380



Iris 230 : Sprinter
Iris 380 : Marathon

5

Iris 230



RACLET

Caravanes Plantes

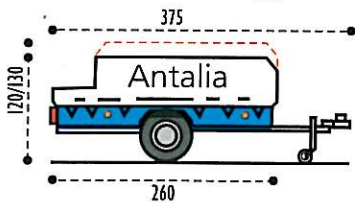
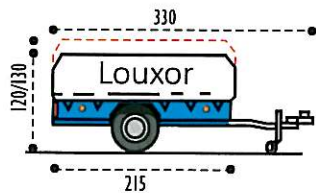
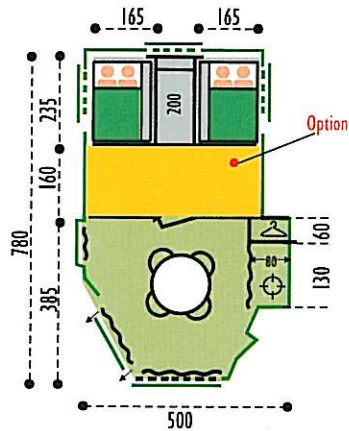
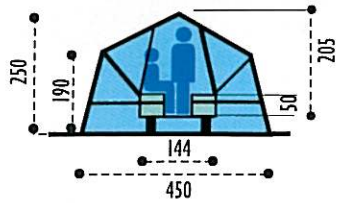

LOUXOR



LOUXOR
350 KG

Antalia
375 KG

Poids à vide
Weight (excl. baggage)
Eigengewicht
Leergewicht
P.A.V.
Peso propio

LOUXOR
495 KG

Antalia
495 KG
650 KG (NL)

Poids total en charge
Maximum loaded weight
Max. toelaatbaar gewicht
Max. Gesamtgewicht
P.A.P.C.
Peso total

464 L

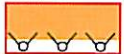

515 L



1238 L

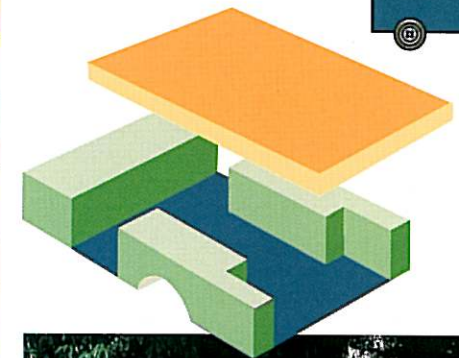



ANTALIA



Sommiers à lattes isolés.
Insulated slatted beds
Isolierte Lattenrostbetten
Latten bodem
Letto a doghe
Somier de láminas



Caravanes Pliantes

7



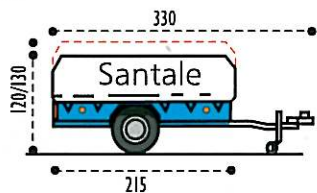
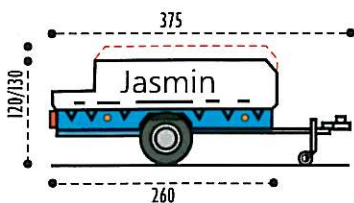
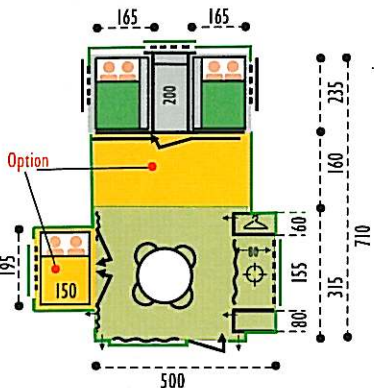
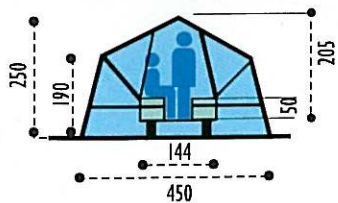

Jasmin



Jasmin 375 Kg
Santale 350 Kg

Poids à vide
Weight (excl. baggage)
Eigengewicht
Leergewicht
P.A.V.
Peso proprio

Jasmin 495 Kg
650 Kg (NL)
Santale 495 Kg

Poids total en charge
Maximum loaded weight
Max. toelaatbaar gewicht
Max. Gesamtgewicht
P.A.P.C.
Peso total

1238 L

515 L

464 L

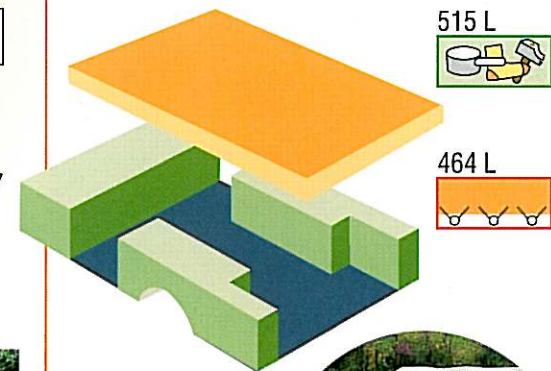

Jasmin



SANTALE



Somniers à lattes isolées
Insulated slatted beds
Isolierte Lattenrostbetten
Latten-bödem
Letto a doghe
Somier de lămmas



9



Casavanes Pliantes

SOLENA®

270 Kg

Poids à vide
Weight (excl. baggage)
Eigengewicht
Leergewicht
P.A.V.
Peso propio

400 Kg

Poids total en charge
Maximum loaded weight
Max. toelaatbaar gewicht
Max. Gesamtgewicht
P.A.P.C.
Peso total

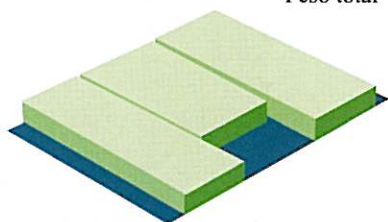

940 L

336 L

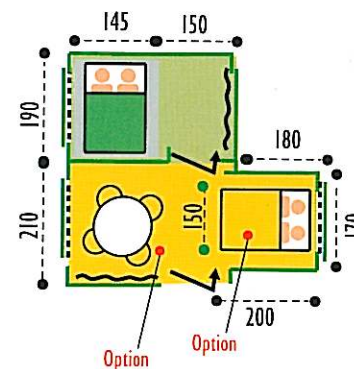
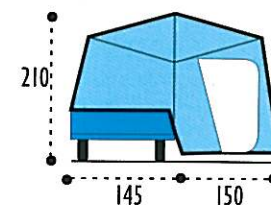
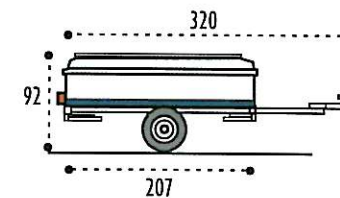

Montage ultra rapide sans piquets.
Very quick erecting without pegs.
Ongelovelijk snel op te zetten
Zonder tentharingen
Sehr schneller Aufbau ohne Häringe.
Montaggio ultra rapido senza picchetti.
Montaje ultra-rápido sin piquetas.

Option
 Optie
 Nach Wahl
 Optional
 Opcional
 Opzione



FABRICATION FRANÇAISE
 2 ANS DE GARANTIE



Option Tendeler
 Optie Sun canopy
 Nach Wahl Sonnensegel
 Optional Zonneluifel
 Opcional Visera-toldo parasol
 Opzione Tendalino
 180 cm



www.raclet.com

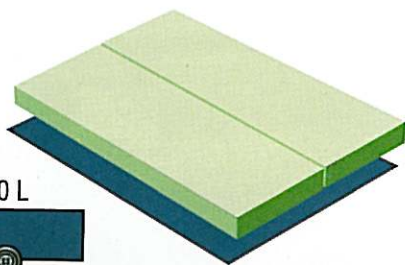
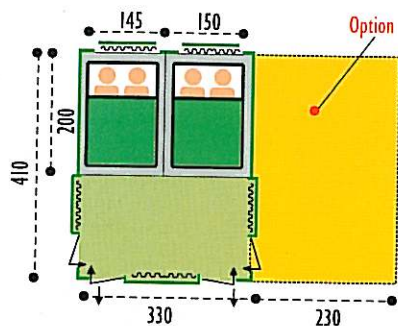
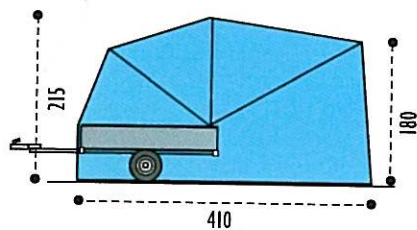
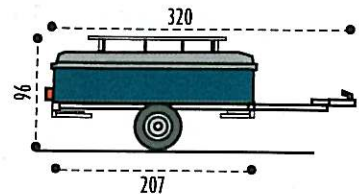

940 L



440 L



ESCAPADE®



270 KG

Poids à vide
Weight (excl. bagage)
Eigengewicht
Leergewicht
P.A.V.
Peso proprio

400 KG

Poids total en charge
Maximum loaded weight
Max. toelaatbaar gewicht
Max. Gesamtgewicht
P.A.P.C.
Peso total



Option
Optie
Nach Wahl
Optional
Opcional
Opzione



Option Tendelet,
Optie Sun awning
Nach Wahl Luifel
Optional Sonnenschutz
Opcional Parasole
Opzione Visera-parasol
170 cm

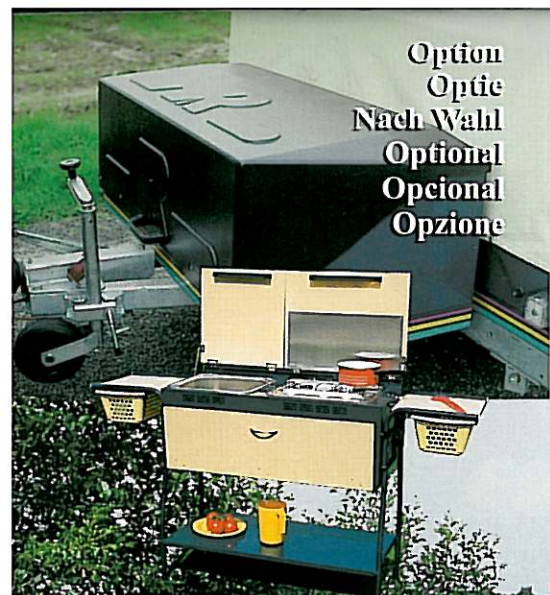

Caravanes Pliantes



13



380 Kg

Poids à vide
Weight (excl. bagage)
Eigengewicht
Leergewicht
P.A.V.
Peso proprio

495Kg - 650 Kg (NL)

Poids total en charge
Maximum loaded weight
Max. toelaatbaar gewicht
Max. Gesamtgewicht
P.A.P.C.
Peso total

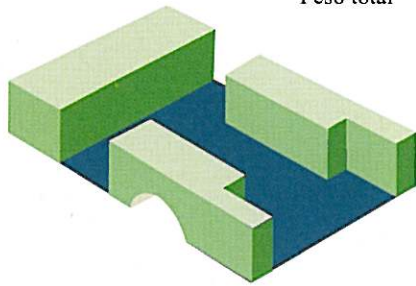

1238 L



515 L



Quick stop

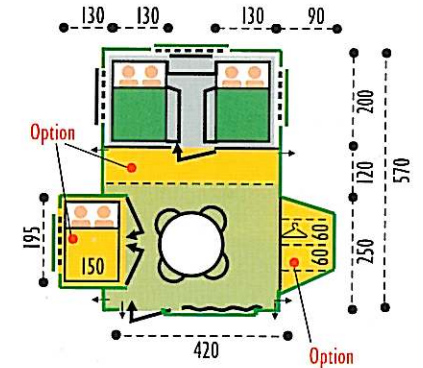
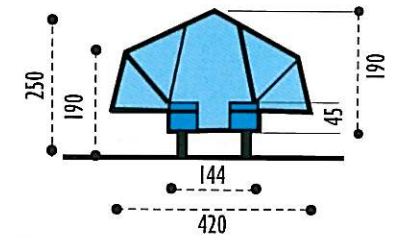
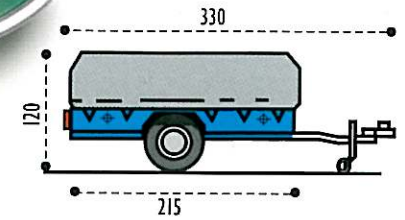
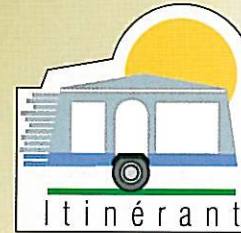

Montage ultra rapide sans piquets.
Very quick erecting without pegs.
Ongelovelijk snel op te zetten
Zonder tentharingen
Sehr schneller Aufbau ohne Häringe.
Montaggio ultra rapido senza picchetti.
Montaje ultra-rápido sin piquetas.



Option Tendelet
 Optie Sun awning
 Nach Wahl Luifel
 Optional Sonnenschutz
 Opcional Parasole
 Opzione Visera-parasol
 160 cm



Caravanes Plantes

15



450 KG
 Poids à vide
 Weight (excl. baggage)
 Eigengewicht
 Leergewicht
 P.A.V.
 Peso propio

495 KG / 650 KG NL
 Poids total en charge
 Maximum loaded weight
 Max. toelaatbaar gewicht
 Max. Gesamtgewicht
 P.A.P.C.
 Peso total

GLOBE TROTTER

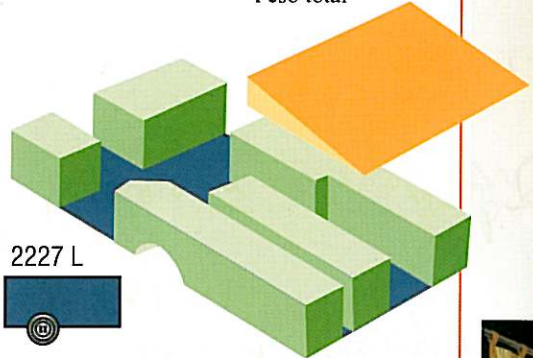

2227 L

1148 L 239 L



Pompe à eau
 Water pump
 Waterpomp
 Wasserpumpe
 Pompa dell'acqua
 Bomba de agua



Montage ultra rapide sans piquets.
 Very quick erecting without pegs.
 Ongelovelijk snel op te zetten
 Zonder tentharingen
 Sehr schneller Aufbau ohne Heringe.
 Montaggio ultra rapido senza picchetti.
 Montaje ultra-rápido sin piquetas.

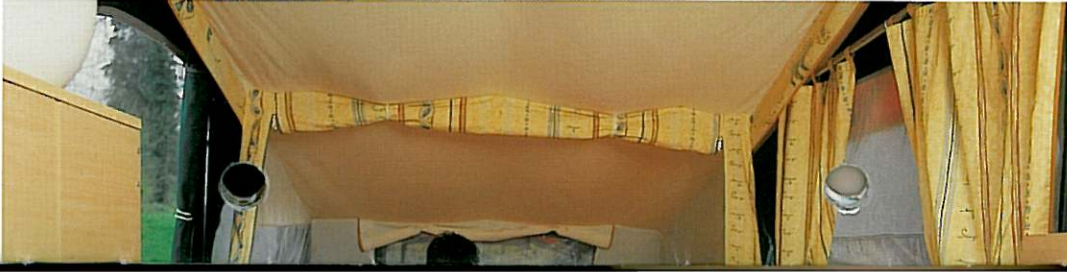
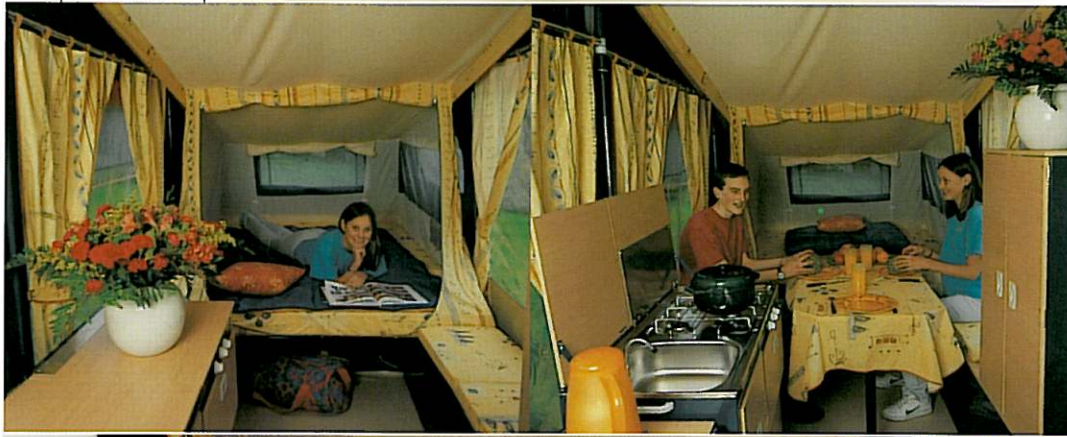
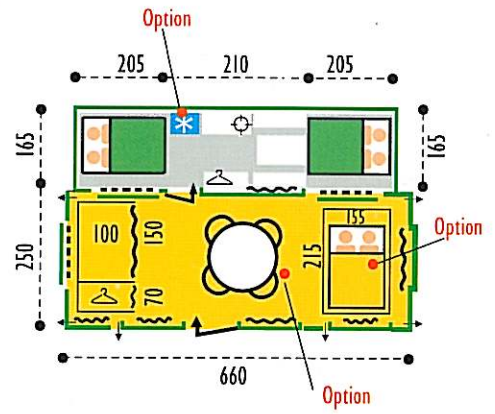
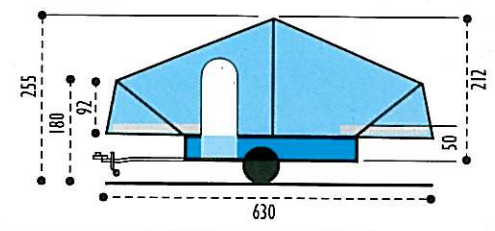
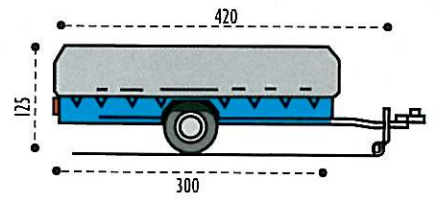

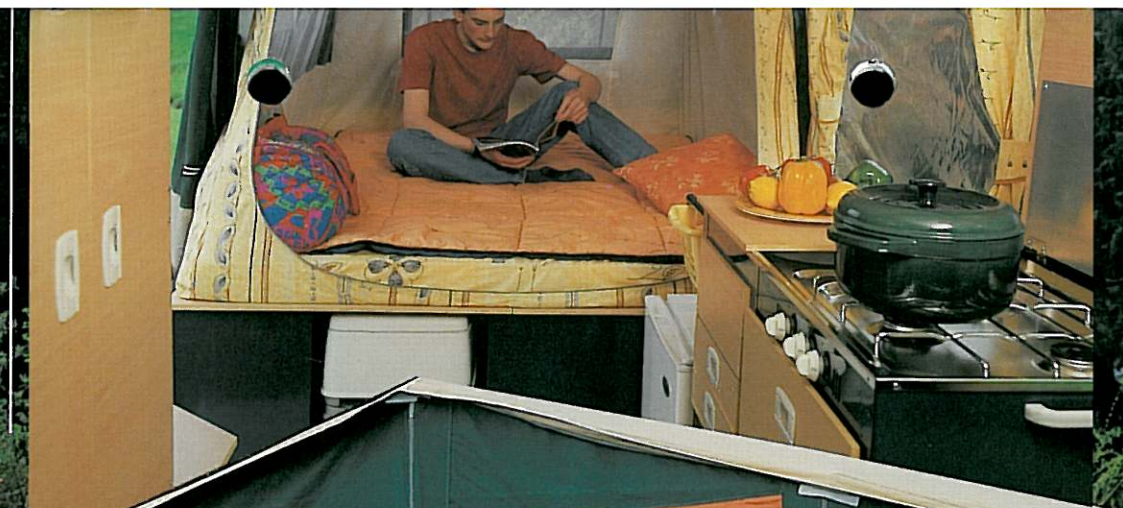

- Option Pare-soleil
- Optie Sun awning
- Nach Wahl Luifel
- Optional Sonnenschutz
- Opcional Parasole
- Opzione Visera-parasol
- 210 cm



Super Quick Stop



17



RACLET
Caravanes Pliantes

EQUIPEMENTS ET ACCESSOIRES

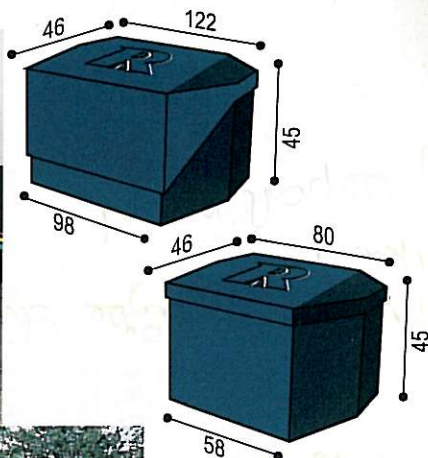

- 1** Coffre sur flèche
Towbar storage box
Disselbak
Deichselkasten
Porta frigo per timone
Depósito timón

Les équipements ainsi que les caractéristiques peuvent varier en fonction des pays.

The fittings as well technical data can vary according to each country.

Die Ausstattungen sowie die technischen Angaben können je nach Land variieren.

De uitvoeringen evenals de technische opgaven kunnen per land verschillen.

Los equipos y las características técnicas pueden cambiar de un país a otro.

Le dotazioni e le caratteristiche tecniche potranno variare.

- 2** Pare-soleil
Sun awning
Luifel
Sonnenschutz
Parasole
Visera-parasol
Santale, Jasmin, Louxor, Antalia : 210 cm
3 *Minto, Iris, Acropolis, Globe Trotter* : 210 cm
4 *Solena* : 180 cm, *Escapade* : 170 cm, *Quick Stop* : 160 cm

- 5** Table / Table / Tafel
Tisch / Tavola / Mesa

- 6** Galerie / Roof-rack
Imperial /Gepäckträger
Portebagagli / Baca

- 7** Chambre 2 places adaptable sous plateau
Tweepersons-ondertent
Zusatzschlaf-oder Staukabinen
Camera 2 posti adattabili sotto ripiano
Cuarto de 2 puetos adaptables bajo repisa

- 8** Coffres sous banquettes
Bench storage lockers
Bankkasten met veel bergruimte
Staukästen unter Sitzflächen
Bauletti sotto panchine
Cofres bajo los asientos

- 9** Chambre annexe
Bedroom annexe
Schlafkabine
Slaapcabine
Habitacion
Camera supplementare

- 11** Dossieret banquette
Back-rest
Rugleunigen
Rückenlehnen
Intelaiatura
Respaldos asientos
Santale, Jasmin, Louxor, Antalia, Quick Stop, Globe trotter

- 12** Meuble cuisine
Kitchen unit
Keukenblok
Küchenblock
Blocco cucina
Bloque cocina

- 12** *Iris, Acropolis* : 51 L

- 13** *Iris, Acropolis, Solena Escapade* : 51 L
Louxor, Santale, Quick Stop, Globe Trotter : 100 L

- 14** *Jasmin, Antalia* : 181 L

- 15** Essieu freiné, recul automatique
Axle with brake
Oplooprem met terugrijautomaat
Achse mit Bremsvorrichtung und Rückfahrautomatik
Assie con freno
Eje con freno

- 16** Roue jockey / Jockey wheel
Telescopisch neuswiel
Bugrad / Bota jockey
Rueda jockey

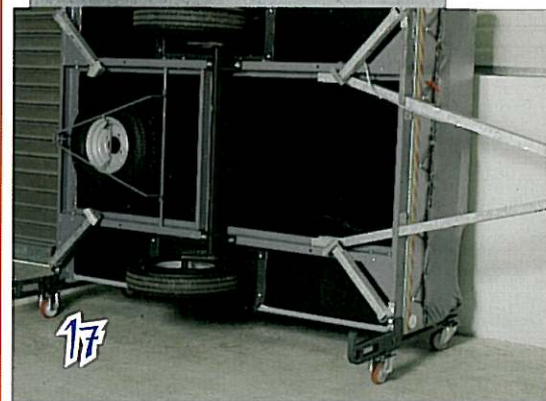
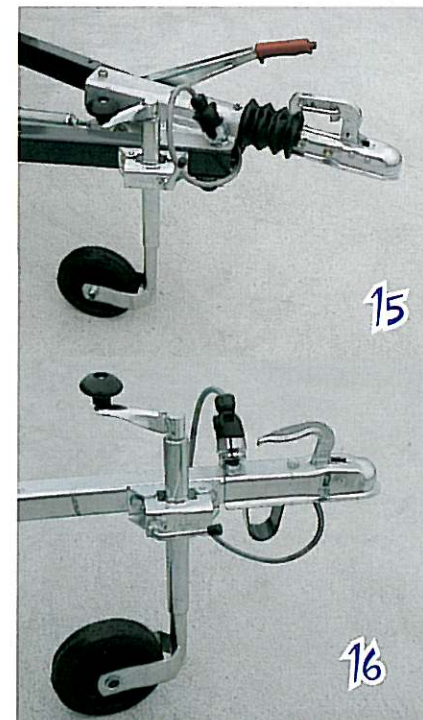

15

16

17



4



5

Santale, Jasmin,
Solena, Quick Stop

10 Aération chambre double volet
Ventilated inner tents
Goede ventilatie mogelijkheden
Zimmerbelüftung-Doppelvorhänge
Finestra camera sotto ripiano
Ventilación habitaciones



6

17 Berceaux de garage
Storage brackets
Kantellagers
Kippvorrichtung
Archi di remessagio
Mensulas de estacionamiento

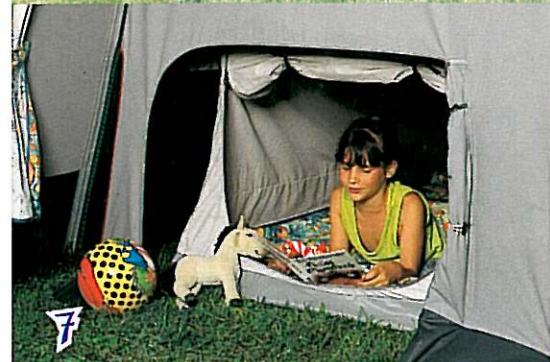

7



8



9



12



13



9



10



11



14

CARROSSERIE



CARROSSERIE

Tôle acier électrozinguée, revêtement polyester.
Châssis galvanisé*
Suspension : roues indépendantes sur barre de torsion caoutchouc

BODYWORK

Electro zinc-treated sheet metal, epoxy painted finish
Galvanised chassis*
suspension : independent wheels, rubberised torsion units

WAGENBAK

Verzinkt en epoxy gelakt
Gegalvaniseerd chassis*
Vering : onafhankelijke wielophanging, rubber geveerd

KAROSSERIE

Elektrisch verzinkt Stahblech mit Polyester-Ueberzuzl
Galvanisiertes Fahrwerk*
Einzelradaufhängung mit gummielagerter Torsionsstabfederung

CASSONE

Lamiera acciaio elettrozingata, rivestimento poliester
Cassone galvanizzato*
Suspensione : ruote indipendenti su aste di torsione in gomma

CAJA

Chapa electro-zincada, revestimiento poliéster
Chasis galvanizado*
Suspensión independiente sobre goma de torsión de caucho

(*Sauf, except, behalve, auBer, eccetto, excepto Mint)

Volume - Volume - Inhoud - Volumen - Volume - Volumen



total
total
totaal
gesamt
totale
total



rangement
storage
opbergruimte
verstauen
assetamento
aparcamiento

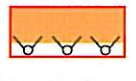

sous bâche
under cover
afdekzeil
unter der Plane
sotto copertone
bajo toldo



DÉPLIAGE ULTRA RAPIDE

Easy action erecting system
Fameus opzetsysteem
Automatischer Aufbau
Apertura automatica
Apertura automática

ARMA Clic®

Armature télescopique
entièrement solidarisée :
ARMAclic est deux fois plus légère
qu'une armature acier traditionnelle.
Elle se déploie et se replie en un clin
d'oeil. Le réglage est fiable et très simple
grâce à un astucieux système de bagues.
ARMAclic est en aluminium anodisé
inaltérable diamètre 28 mm. Système
breveté.

Fully inter-connected in dural it unfolds
and re-folds again into one piece.
International patents

Parapluframe. Gemakkelijk in en uit
te vouwen aluminium voortent frame.
Het parapluframe is zo eenvoudig, je
hoeft niet meer te stoeien met stokken,
want alles zit aan elkaar vast en is
eenvoudig door één persoon op te
zetten. Internationaal gepatenteerd.

Aluminium-gestänge in einem
Stück. Patentiertes system
Armatura in alluminio
interamente unita. Modello
brevettato

Armodura aluminio del
avance, de uno sola pieza
(opcional).

Sistema patentado



Caravanes Pliantes

Haut Eclair
72600 Mamers - France
Tél 02 43 31 12 30
Fax 02 43 31 12 31
contact@raclet.fr
<http://www.raclet.fr>

Notre catalogue ne peut être considéré
comme contractuel. Nous nous réservons
la possibilité d'apporter toutes
modifications que nous jugeons utiles à
nos produits.

Our catalogue cannot be considered as
contractually binding. We reserve the right
to make any modification we consider
necessary to our products.

Deze folder mag niet als contractueel
worden beschouwd. Raclet behoudt zich
het recht voor om technische en
commerciële verbeteringen door te
voeren.

Unser katalog ist vertraglich nicht
bindend. Wir behalten uns das Recht vor,
jederzeit für uns nützliche Änderungen
vorzunehmen.

Il nostro catalogo non può essere
ritenuto contrattuale, ci riserviamo la
possibilità di apportare ogni modifica da
noi ritenuta utile ai nostri prodotti.

Nuestro catalogo no puede estar
considerado como carácter contractual.
Nos reservamos la posibilidad de
añadir toda modificación que sea
oportuna.