

Hymmer Exsis-i

THE NEW LIGHTNESS



Hymmer Exsis-i

HYMER



Bernhard Kibler is in charge of motorhomes at Hymer.
He has been with the company since 1989.

Hymer Motorhomes

Always an original

For generations of holidaymakers, Hymer is the epitome of holidaying on wheels. And there is a good reason for this: Since the invention of the motorhome by Erwin Hymer in 1961, our vehicles have set standards and affect developments in this area of industry. Whatever class you are searching in: at Hymer you will always find the original.

We use this edge to offer you more – more choice, more comfort, more safety. Anyone who has been on the road in a Hymer motorhome will appreciate the difference. The thing that makes travelling a unique adventure here is the diversity of high quality details. And more than 50 years of experience that we draw upon to bring these details for you into perfect harmony.

You can gain a particularly good impression of this from the **new model year**. In the second half of this brochure you can find a detailed overview of the main equipment features, accompanied in each case by images and an explanation. This way, you can get to know the model series of your choice even better.

Of course, a description is no substitute for first-hand experience of the original. You should therefore take advantage of the opportunity at your Hymer trading partner to carefully look

around your dream vehicle and, better still, take it for a test drive. Our close-knit dealer and service network in Germany and Europe provides you with the assurance that there is always first-class support nearby.

A general overview of the Hymer model series can be seen on the next double page. Here, you can compare the

“For us, the name Hymer is a bond. And for our customers a promise. These motorhomes offer the best performance and the best quality in any vehicle category.”

basic features of our motorhomes easily and conveniently – as an initial orientation aid to determine which vehicles best match your individual requirements. Further information about all available floor layouts and equipment versions can be obtained as always

from your Hymer trading partner or www.hymer.com. You can also order the latest catalogues from there for all of the models.

If, in addition, you are among the growing number of Facebook users, we would be delighted to hear about your journeys and experiences at www.facebook.com/hymerAG. Many of

our customers contribute to this site on a regular basis and make it a lively and informative place to visit. You can find valuable tips covering the whole spectrum of holidaying on wheels with the original. Experience them yourself: the mobile homes from Hymer.









Bernhard Kibler

Hymer Motorhomes

Comfort for everyone's needs

		SPECIAL EDITIONS			THE MODEL SERIES	
VEHICLE MODEL	Model series	Van Premium 50	Tramp Premium 50	Exsis-i Premium 50	Compact	Tramp CL
	Features					
		The compact edition	The elegant edition	The streamline edition	The sporty companion	Simply spacious
	Profile	Sporty semi-integrated vehicle with exclusive design and additional equipment	Semi-integrated vehicle with exclusive design and comprehensive additional equipment	Agile integrated vehicle with additional equipment for even more living comfort	Compact semi-integrated vehicle with a high level of driving comfort for unlimited flexibility	Generous semi-integrated vehicle with a high level of driving and living comfort
	Chassis					
WEIGHT	Under 3500 kg	<input checked="" type="checkbox"/>	<input checked="" type="checkbox"/>	<input checked="" type="checkbox"/>	<input checked="" type="checkbox"/>	<input checked="" type="checkbox"/>
	Over 3500 kg	<input type="checkbox"/>	<input type="checkbox"/>	<input type="checkbox"/>	<input type="checkbox"/>	<input type="checkbox"/>
WIDTH	≈ 2 m	<input checked="" type="checkbox"/>	<input type="checkbox"/>	<input checked="" type="checkbox"/>	<input checked="" type="checkbox"/>	<input type="checkbox"/>
	2.22 m	<input type="checkbox"/>	<input type="checkbox"/>	<input type="checkbox"/>	<input type="checkbox"/>	<input type="checkbox"/>
	2.35 m	<input type="checkbox"/>	<input checked="" type="checkbox"/>	<input type="checkbox"/>	<input type="checkbox"/>	<input checked="" type="checkbox"/>
EQUIPMENT	Multi-purpose double floor	<input type="checkbox"/>	<input type="checkbox"/>	<input type="checkbox"/>	<input type="checkbox"/>	<input type="checkbox"/>
	Winterised as standard	<input type="checkbox"/>	<input checked="" type="checkbox"/>	<input checked="" type="checkbox"/>	<input type="checkbox"/>	<input checked="" type="checkbox"/>
	Safety comes as standard at Hymer	+ + + AIRBAGS + + + ABS + + + ESP + + + ELECTRIC ADJUSTABLE WINDOWS + +				
						

From the compact semi-integrated to the integrated vehicles of the premium class, every Hymer motorhome model series has its own particular profile – and also offers you a diverse range of floor layouts and equipment options. Here, you can find the right vehicle to meet your individual desires and needs.

Exsis-i	B Class	StarLight	StarLine	B Class SL	Model series	VEHICLE MODEL
					Features	
The new lightness	The benchmark for mobile holidays	Easygoing pleasure	Better by "star"	Comfort without compromise	Profile	
Integrated vehicle of the 3-ton class with a very high level of driving and living comfort	Premium integrated vehicle with great amount of space and very high level of living comfort	Premium integrated vehicle under 3.5 tons with exclusive driving and living comfort	Premium integrated vehicle with heated double floor as well as exclusive driving and living comfort	Exclusive integrated vehicle with the highest level of comfort and particularly generous amount of space	Chassis	
						
			–	–	Under 3500 kg	WEIGHT
–					Over 3500 kg	
–	–	–	–	–	≈ 2 m	WIDTH
	–	–	–	–	2.22 m	
–					2.35 m	
–		–			Multi-purpose double floor	EQUIPMENT
					Winterised as standard	
+ AIRBAGS + + + ABS + + + ESP + + + ELECTRIC ADJUSTABLE WINDOWS + + +					Safety comes as standard at Hymer	
						

The new lightness – in the 3 ton category

Hymer Exsis-i

Lots of flexibility and lots of comfort are characteristics of mobile holidaying. The Hymer Exsis-i combines both in a particularly elegant way. The slimline vehicles weigh in at considerably under three tons in traffic-ready state. This makes the Exsis-i the first A Class motorhome in this weight sector.

Despite its generous, convenient layouts and the comfortable standing height of 1.98 metres inside the vehicle, the Hymer Exsis-i is just 2.77 metres high and 2.22 metres wide. These compact dimensions and its optimally positioned wheelbase lend it a particularly high level of manoeuvrability. However, the thing that affords it a car-like status is not just its excellent road behaviour but also its weight classification.

All seven floor layouts have an unladen weight of less than three tons – including the comprehensive standard equipment. From 2,610 kilograms with the Exsis-i 504, the range in road-ready state extends to 2,950 kilograms with the Exsis-i 698. Even when fully laden with passengers (4 people) and with individual additional equipment, there is still ample scope to load up the vehicle and utilise the garage capacity of 250 kilograms without exceeding the 3.5 ton permissible weight. Any weight restric-

tions in road traffic that apply above this limit are thereby avoided and the vehicle maintains its full flexibility.

There is also unrestricted mobility in the Hymer Exsis-i in terms of weather. Its winterised body with fully foamed PUALL walls, foamed-filled GFK floor and its insulated and heated installation area for lines, fresh water and grey

“There is no need to be extra cautious here with weight. Just load up as normal. The Exsis-i’s reputation as an innovative 3 ton class vehicle precedes it.”

water tanks makes it the leading all-season vehicle in its class. Thanks to optimised heat distribution, you can enjoy a well-balanced, cosy atmosphere throughout in the motorhome and, at the same time, also avoid any unnecessary energy loss. Equally as efficient and

economical is the pleasant interior lighting, which features modern LED technology throughout.

The high quality ambience in the living area of the Exsis-i is defined by the generous lounge seating group that offers space for up to 6 people depending on the layout. With the exception of the opposing seating group in the Exsis-i 644,

Simon Leiprecht, Head of Prototypes

the swivelling pilot seats and the comfortable L-shaped bench seat form a group around the large, sliding table. As an additional proper seating space, there is a padded folding seat next to the entry door in four models, which, when folded up, allows easy access to the cab.



In the rear, you have a choice between longitudinal single beds, a lateral double bed and the classy queen-size bed of the Exsis-i 698. All of the floor layouts also feature a drop-down bed above the cab with 1.50 metres in width. **Additional models are** the Exsis-i 614

with extra-wide rear lateral bed and the Exsis-i 678 with single beds and large comfort washroom. The floor layouts of the Exsis-i 504 to the 674 are equipped with a variable premium washroom that can be converted from a washing area/WC into a water-tight shower cubicle by revers-

ing the wall. To ensure that water drains off properly if the vehicle is on a slight angle, the shower tray in all wash rooms is equipped with two drainage points. **High quality details such as these** are typical for the Hymer Exsis-i. Have a look yourself – and discover the new lightness!



Ample scope for additional load: All models of the Hymer Exsis-i stay way under the 3.5 ton threshold – even with front passenger and special equipment. This means that you can pack lots of holiday equipment into the vehicle without overloading it. This is demonstrated by the three calculation examples in the table.

The new lightness – in the 3 ton category



Weight	Exsis-i 504	Exsis-i 578	Exsis-i 674
Start weight*	2,610 kg	2,800 kg	2,910 kg
Special equipment:			
– Exsis-i comfort package	78 kg	78 kg	78 kg
– Fiat 2.3 litre engine with 148 HP	21 kg	1 kg	1 kg
– Automatic transmission	17 kg	17 kg	17 kg
– Second leisure battery	30 kg	30 kg	30 kg
– 3.5 m awning	32 kg	---	---
– 4.5 m awning	---	45 kg	45 kg
– Radio/DVD player	1 kg	1 kg	1 kg
– 17" TFT flat-screen	7 kg	7 kg	7 kg
– TFT bracket	4 kg	4 kg	4 kg
– Oyster 85 digital satellite system	15 kg	15 kg	15 kg
Water tank full (difference)	80 kg	80 kg	80 kg
Front passenger	85 kg	85 kg	85 kg
Total weight	2,980 kg	3,163 kg	3,273 kg
Maximum permissible weight	3,500 kg	3,500 kg	3,500 kg
This is how much additional weight you can load:	More than 500 kg	More than 300 kg	More than 200 kg

*Weight in traffic-ready state in accordance with EN1646-2: Basic vehicle with standard equipment inc. 75 kg weight of driver, filled fuel tank, water tank with 20 litres, filled aluminium gas bottle and electric hookup cable.

Hymer Exsis-i – Living comfort



"When you enter the generous interior, you can barely believe how slim-line the vehicles are from the outside."

Frank Venter, Head of Design



Hymer Exsis-i – Living comfort





03



The amount of space in the comfortable lounge seating groups of the Exsis-i is as great as it is diverse. Up to five seating spaces are available in the classic layout with L-shaped bench seat. In the Exsis-i 644 with its wide opposing seating group, there is even enough space for six people.



05



06

- 01 View into bright living space of Exsis-i 698 with colourful "Charbonnel" fabric design.
- 02 Lounge seating group with "Castello" fabric design and large, sliding table in the Exsis-i 578.
- 03 Comfortable bench seat next to entry door as additional fifth seating space, as seen here in the Exsis-i 674.
- 04 Living area of the Exsis-i 644 with comfortable opposing seating group, as seen here in "Kalmar" fabric design and "Trentino pearwood" furniture finish.
- 05 Additional seating space in the Exsis-i 698 seen here folded up – as a practical holder for newspapers and drinks.
- 06 L-shape bench seat in the Exsis-i 674 with "Viola" fabric design and light "Umbria Select" furniture finish.



01



02



03



04

- 01 Exsis-i 578 with "Castello" fabric design.
- 02 Exsis-i 504 with "Umbria Select" furniture finish and "Trinidad" leather-fabric combination.
- 03 Entrance area in the Exsis-i 578 with optional, multi-adjusting TV bracket.
- 04 Exsis-i 674 with pilot seats turned around to form the seating group and large drop-down bed above the cab.
- 05 Large, adjustable table in the Exsis-i 578.
- 06 Exsis-i 698 with "Trentino pearwood" furniture finish and "Charbonnel" fabric design.



05



06

Hymer Exsis-i – Living comfort



"Its class is evident by the harmonious atmosphere and the high quality equipment of the motorhome."

Jacqueline Wolff, Textile Designer



Hymer Exsis-i – Sleeping comfort



“Lots of headroom and comfortable access are typical features of all Hymer beds. This also includes, of course, the drop-down bed of the Exsis-i.”

Hansi Wiest, Team Leader Interiors



Hymer Exsis-i – Sleeping comfort



01 02



04



03



The drop-down bed at the front and all of the beds in the rear are fitted as standard with anatomically strengthened multi-zone cold foam mattresses. The high quality padding to extend the single beds and the opposing seating group in the Exsis-i 644 are likewise particularly friendly on the back.



05



06

- 01 Large single beds with a standard filler pad to extend the sleeping area, as seen here in the Exsis-i 578.
- 02 Extension of single beds to form one complete sleeping area by means of optional filler pad.
- 03 Comfortable access to holiday clothes in the wardrobes above the single beds.
- 04 Sleeping area in the rear of the Exsis-i 674 with single beds and surrounding roof storage cupboards in "Umbria Select" finish.
- 05 Bed access in the Exsis-i 674 with large, fixed steps.
- 06 Converted opposing seating group in the Exsis-i 644 with optional extension as third double bed.



01



02

- 01 High wardrobe next to queen-size bed in the Exsis-i 698, with counterpart on opposite side.
- 02 Huge, easily accessible bed box with deep stowage compartments under the queen-size bed.
- 03 Queen-size bed in the Exsis-i 698 in its day and reading position: pushed up close to the wall with upright top section.



Hymer Exsis-i – Sleeping comfort



01 03



02



04

- 01 View of large single lateral bed in the rear of the Exsis-i 504 with "Umbria Select" furniture finish.
- 02 Double lateral bed in the rear of the Exsis-i 644 with roof storage cupboards in "Trentino pearwood" finish.
- 03 Single lateral bed in the Exsis-i 504 with extra-wide sleeping space.
- 04 Top section of lateral bed in the Exsis-i 504 with unique width of 1.34 metres and large vent window.



01



02



03

- 01 Variable premium washroom with rotating, water-tight shower wall – seen here as a shower cubicle with closed door.
- 02 Variable premium washroom as open washing area/WC with practical stowage space above the bench toilet, as seen here in the Exsis-i 674.
- 03 High quality washroom equipment with large table top, frosted glass skylight and washroom cabinets in "Trentino pearwood" furniture finish.
- 04 Wide bench toilet in the variable premium washroom, in front of it the shower tray with two drainage points and optional slatted frame.



Hymer Exsis-i – Washing comfort



"In the comfort washroom of the Exsis-i 678 and 698 the shower can be separated. This means that feet stay dry in the washroom." Rainer Wingart, Product Manager



Hymer Exsis-i – Kitchen comfort



"Culinary artists have free realm here. With so much stowage space, everything you need is onboard and always within easy access." Hansi Wiest, Team Leader Interiors





01



02



03

- 01 Large side kitchen with flexible drawer partitions, extendible worktop, in "Trentino pearwood" finish – as seen here in the Exsis-i 674.
- 02 The work surface can be extended in a twist of the hand – ideally designed as additional worktop space in the kitchen.
- 03 Jumbo refrigerator (150 litres) with separate freezer compartment: available on request in every Exsis-i model.
- 04 The kitchen in the Exsis-i 504 in "Umbria Select" furniture finish, with LED head chef lighting under the large roof storage cupboard.



04

Hymer Exsis-i – Storage comfort



“In the numerous, deep roof storage cupboards of the Exsis-i there is plenty of space for your holiday clothing.”

Stefan Ziegler, Furniture Maker





01



02

- 01 Room-high wardrobes in the rear of the Exsis-i 504, with second clothes rail on the middle shelf.
- 02 Freely accessible wardrobe at the foot-end of all longitudinal single beds, as seen here in the Exsis-i 578.
- 03 Extra-deep high wardrobe in the Exsis-i 674, in addition to both large cupboards under the bed.



03

Hymer Exsis-i – Inside temperature

Systematic heat

Perfect heat insulation, cleverly conceived heating and "breathable" interior walls that capture moisture and release it again – in the Hymermobil Exsis-i, a cosy and healthy atmosphere is assured all year round. Frost-protected installations also mean that these vehicles are winterised.

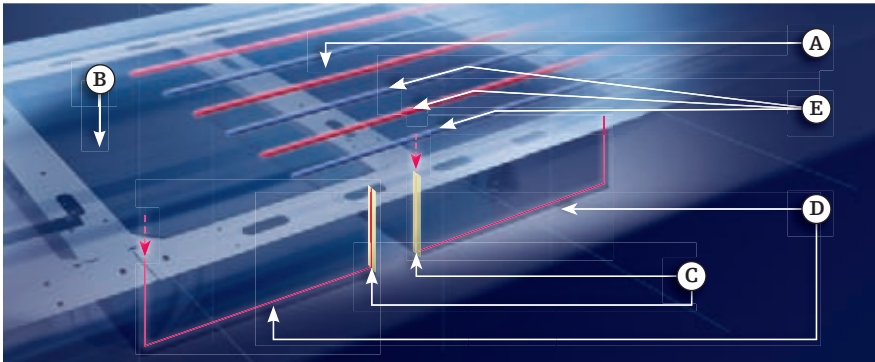

Insulated and heated underbody:
The floor conceals the fresh water (A) and grey water tank (B) in insulated trays (C), which have hot air flowing through them (D).

All of the installations (E) are in a heated area of the living space, protected against frost.



Heated exterior stowage compartments:
Both the garage in the rear and also the stowage compartment beneath the lounge bench seat are supplied with hot air from the heating system. In this way, cold-sensitive objects and items of luggage can be stored there without worry.

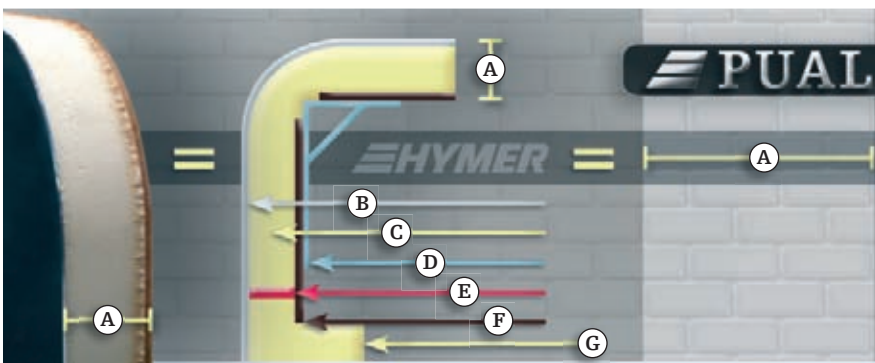

Unique Hymer-PUAL wall structure:
Just 3.5 centimetres thick but the PUAL wall in the Hymermobil has the insulating effect of an 80 cm brick wall (A). The fine-pored polyurethane foam (B) is joined completely to the sturdy aluminium outer skin (C) and the breathable plywood layer (D) inside the vehicle.

The prevents cold bridges and ensures a very high level of stability – likewise provided by the plastic corner profile surround (E) and the full elastic bond (F) to the vehicle roof. The foam-filled GFK floor (G) rounds off the heat protection.



High heating power included:
With 6.000 watts of power, the Truma Combi 6 heater, installed as standard, has no trouble bringing the temperature inside the vehicle up to a cosy level even when it is freezing outside. Thanks to its central location under the seating group, the heat is distributed optimally throughout the vehicle.

Hymer Exsis-i – Inside temperature



01

Instrument panel:
Blower on the windscreen



02

Living space:
Hot air outlets at window and
under the L-seating group

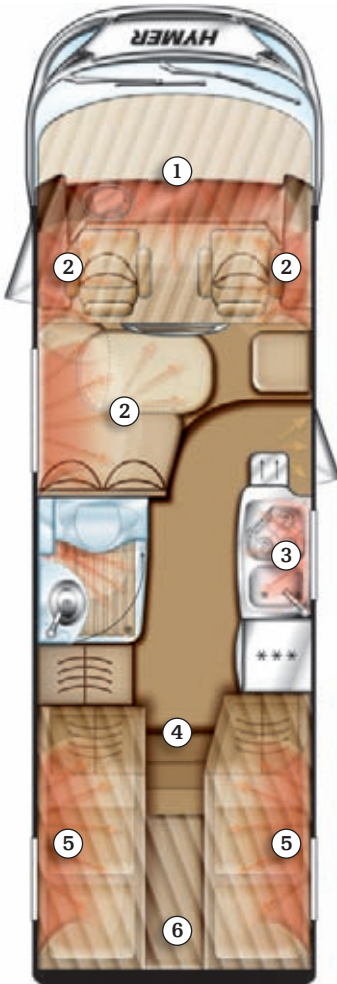

03

Kitchen:
Hot air outlet at window

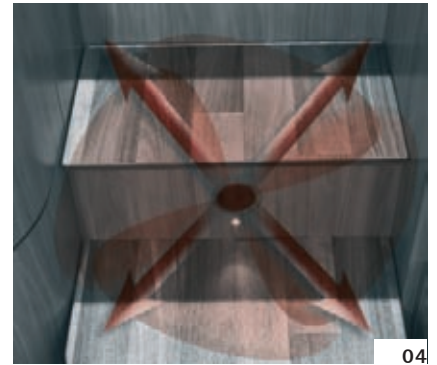

04

Rear area:
Hot air outlet at steps

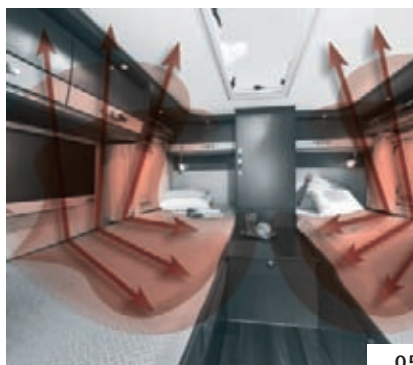

05

Sleeping area:
Hot air curtain all around rear beds



06

Exterior stowage compartments:
Hot air in maxi stowage
compartment and garage.

Comfortable, well-balanced heat distribution:
The numerous, optimally positioned hot air
outlets guarantee a perfectly
cosy climate throughout the vehicle and
also heat the water tanks and installation.

Hymer Exsis-i – Road safety

Everything in sight, everything within reach

As well as the high level of driving comfort in the Hymer Exsis-i, the range of safety equipment is like no other in this category. Thanks to best visibility in the cab and electronic safety systems, you always feel in control – even in critical situations.



Driver and front passenger airbag:
Both seats in the cab are equipped as standard with Fiat airbags. In the event of an accident they are triggered in a fraction of a second and prevent severe head injuries. If an airbag is triggered, the seat belt is tensioned at the same time.

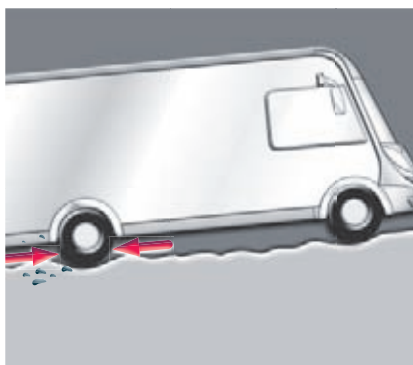

Anti-skid regulation (ASR):
If traction is lost at a wheel (wheel slip), this is detected by the electronics and the wheel is braked automatically. This makes it much easier to drive off and accelerate on slippery surfaces and the vehicle is prevented from sliding sideways at the rear.

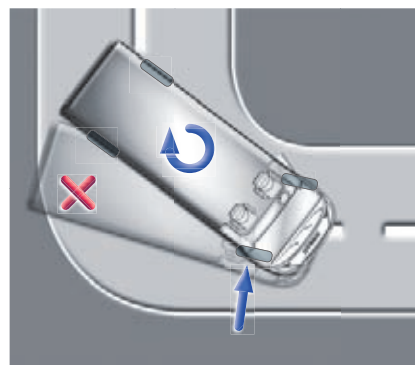

Electronic stability program (ESP):
In critical situations, skidding or breaking out of the vehicle is prevented by engine speed adjustment and by targeted braking of individual wheels.

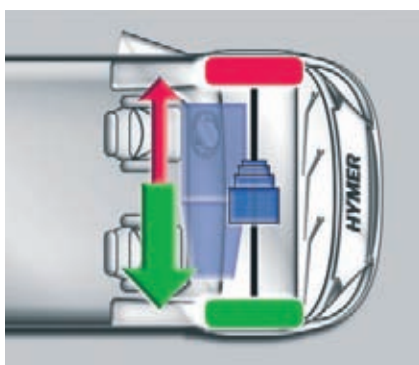

Traction Plus:
In conjunction with ESP, this system ensures greater traction on difficult terrain by distributing the torque to the front wheels in a targeted manner. This makes it easier to drive-off on wet grass, for example, or manoeuvre over muddy ground.

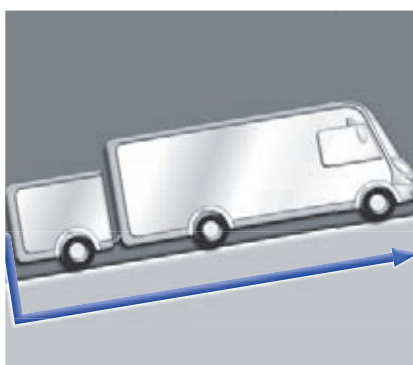

Hill holder:
On gradients of about 5% and steeper, this drive-off assistant maintains the brake pressure briefly after the brake pedal has been released. In this way, rolling back of the vehicle is prevented and comfortable drive-off is enabled – even in reverse.

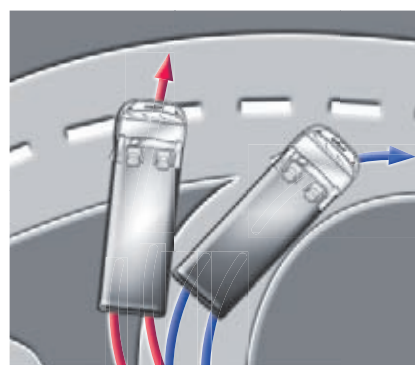

Anti-lock braking system (ABS):
Now somewhat of a classic among electronic control systems, this system prevents the wheels from blocking during emergency braking and, in this way, keeps the vehicle steerable. Familiar, light pulsation at the brake pedal can be detected during ABS intervention.



Perfect all-round vision:
The high panoramic front window and the large side windows in the cab really open up the view in all directions. Moreover, the area right in front of the vehicle is also clear to see from the driver's seat thanks to the lowered instrument panel. This unhindered all-round view

creates not just a unique impression of "open plan" driving. At the same time, it also provides maximum overview and safety. The electric adjustable exterior mirrors and the optional reversing camera serve as a perfect supplement to this.



Good view behind:
The large, heated exterior mirrors are positioned optimally and can be adjusted comfortably by electrical means from the driver's seat. Thanks to the wide angle mirrors on both sides there is no blind spot next to the vehicle.



Good visibility in any weather:
The reliable 2-blade windscreen washer system at the front assures a maximum field of view thanks to its large radius.

This means that the whole road surface is clear to see, even in a heavy downpour – a bonus in terms of safety.



Daytime running lights as standard:
See and be seen is important in equal amounts when travelling by road. The daytime running lights are therefore a standard feature of the Hymer headlights. For unimpeded travel in countries where day driving lights are already compulsory.

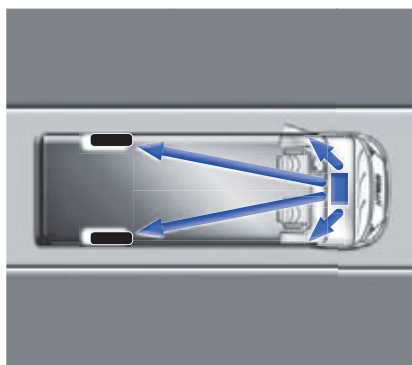

Electronic brake pressure distribution (EBD):
This system apportions the brake force optimally to both axles depending on the situation. In this way, the greatest possible braking force is achieved and, at the same time, the vehicle is prevented from breaking out through "overbraking" at the rear.

HymerExsis-i – Highlights from series production

Everything you need

Slimline in shape but copiously equipped: The Hymer Exsis-i offers you a range of top class features as standard. This allows you to enjoy first-class driving and living comfort – and all of these highlights are already included in the unladen weight under three tons.



Frugal work horse:
The Fiat Multijet II engine with 96 kW / 130 HP embodies economical and sustained driving pleasure thanks to its low standard consumption. The lively and sturdy 4-cylinder turbo-diesel engine complies with the Euro 5 and EEV exhaust emissions standards.



Perfect thermal protection:
The full foam, completely bonded PUAL wall structure provides a cosy living environment without cold bridges. With a thickness of just 3.5 cm, the Hymer PUAL technology, not found anywhere else in the world, achieves the same insulation performance as an 80 cm thick brick wall.



Tailored undercarriage:
The specially developed AL-KO lightweight frame with independent suspension forms the perfect basis for construction of the motorhomes. Its optimally positioned wheelbase assures equal weight distribution, even when the vehicle is fully loaded.



Guard against dirt:
All wheels of the front and rear axle are equipped with large mudguards. They prevent dirt or snow coming into contact with components close to the ground, such as the grey water drainage pipe or exhaust system, and adhering to these areas.



Access without barriers:
The engine compartment beneath the windscreen is easy to open and provides a large access area. This makes it convenient to check and replenish the oil, coolant and windscreen washer fluid. The lamps of the headlights are also easy to access and can be replaced extremely easily.



Permanent protection from underneath:
With its indestructible GFK underbody, the vehicles are practically immune from weather-related damage. Even stone-chips, grit and dirt are kept at bay by the underbody – a secure foundation for the entire service life of the motorhome.

Hymer Exsis-i – Highlights from series production



Thermal protection in cab:

As in the living space, the best insulation properties are assured right at the front of the vehicle. The double skin GFK front-end, filled in between with a PU foam thermal insulation layer, ensures that cold is kept at bay in the front area of the motorhome.



Helpful exterior light:

The powerful LED awning light with rainwater deflector is already part of the standard equipment. It illuminates a wide area outside the entry door, thereby making it safe to alight the vehicle in the dark.



No chance of moisture:

All of the vehicle doors and also all of the exterior stowage compartment flaps and doors are protected against rain and spray water by additional spray water seals. This means that there is no chance of water ingress between the door and frame and nothing will freeze shut in the cold.



View without cold bridges:

The high quality Seitz S7 window frames are equipped with double acrylic glazing – for optimal thermal insulation. The powder-coated aluminium frame is particularly lightweight and sturdy and also features an insulation layer to protect against cold bridges.



Brightness at day and night:

The large crank skylight in the living space lets in lots of daylight directly and creates a pleasant, natural ambience in the interior of the vehicle. At night, the integrated LED spotlights provide a good spread of light.



Undisturbed privacy:

To blackout the front of the vehicle, the Hymermobil has concertina blinds all around the cab area. The high quality curtain material and the colour coded curtain rail create a warm living room atmosphere – and keep nosy glances at bay.

Hymer Exsis-i – Highlights from series production

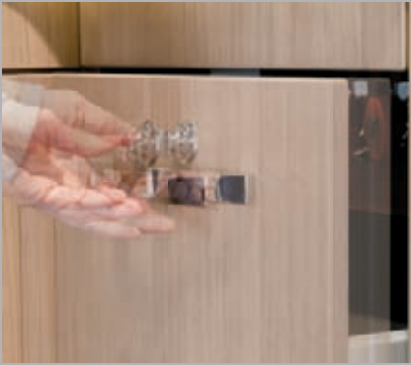

Safe, convenient handling:
All of the kitchen drawers have roller bearings and glide particularly well. They feature a high quality Servo-Soft closing feature and one-handed push-locks that prevent the drawers from opening and rattling when the vehicle is in motion.



Brightly lit work surface:
The head-chef lighting above the worktop provides optimal lighting conditions in the kitchen. With its three recessed LED spotlights in the roof stowage compartment, it lights up the whole surface perfectly – with clear visibility of the cooking pots.

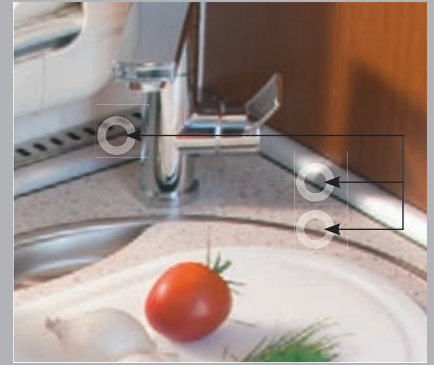

Water-tight design:
All of the connecting joints in the kitchen area are sealed effectively with sealing tape and end strips. This means that the whole surface can be wiped down wet with no worries – and a few little splashes when cooking and washing up are really nothing to worry about.



A place for everything:
The large, easy to reach roof stowage cupboards above the kitchen are ideally suited for the storage of crockery and other tableware. Even if the motorhome is fully loaded, there is plenty of space here to cater for all of the passengers and guests.

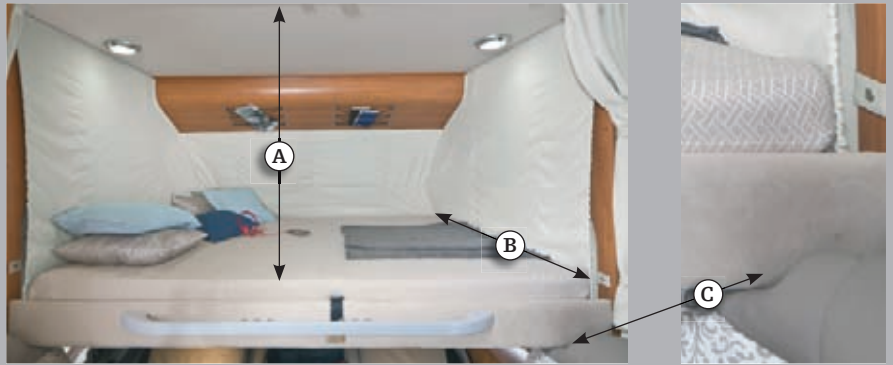

Greater sleeping comfort in the front:
The pull-down bed above the cab also offers maximum freedom of movement and head clearance (A). Its comfortable sleeping area can be used fully without restriction over the whole width of 1.50 metres (B) – even in the front area of the vehicle. In addition to these generous

dimensions, the solid mounting of the pull-down bed also contributes towards its high standard of comfort. In lowered state, the bed rests positively and securely at the head and foot end (C). This makes it easy to climb into bed and is the assurance of an undisturbed and peaceful sleep.



Pleasant seating height in bed:
In approximately three metre high vehicles there is plenty of room above the rear beds to sit up comfortably. Climbing in and out of bed is thereby made particularly easy – there is no need to duck your head here.

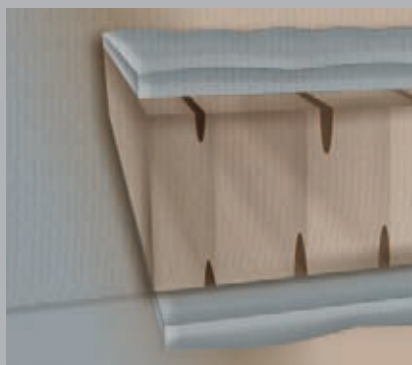

The highest level of sleeping comfort and a healthy sleep:
All of the beds are equipped with high quality multi-zone cold foam mattresses that support each area of the body accordingly. Breathable mattress toppers in the rear assure good ventilation.



Lights on for a night-time read:
At the head of every bed there is an adjustable reading lamp with LED light. The pull-down bed at the front is fitted with spotlights at both ends so that the sleeping direction can be changed if needed, e.g. if the vehicle is slightly slanted.

Hymer Exsis-i – Highlights from series production



More headroom in sleeping area:
Mosquito nets and blackout blinds are fully integrated in the frame of the large clear glass skylights (40 x 40 cm) above the rear beds. In this way, the skylights barely encroach on the interior and permit the full standing height.



Into bed safely and comfortably:
Fixed steps with an extra large surface lead to the beds in the rear. They make it safe and comfortable to climb in and out of bed even in a sleepy state – such as a late night visit to the toilet.



Everything within reach:
There are plenty of stowage compartments and shelves directly on the bed so that glasses, books and drinks are always within reach, even at night. They remain within easy reach even if the single beds in the rear are connected together to form a slumber island.



Lots of stowage space above the beds:
On the backwall and at the foot end of the beds there are large, deep roof storage cupboards, which offer an additional means of storage, e.g. for clothing. This utilises the "air space" above the beds optimally without limiting freedom of movement.



Lights on for a night-time read:
At the head of every rear lateral bed there are two adjustable reading lamps with LED light. Having spotlights fitted at both ends means that the sleeping direction can be changed if needed, e.g. if the vehicle is slightly slanted.



Well stowed away in washroom:
Spacious washroom cabinets with lots of stowage space make it easy to store all of the utensils required, while keeping them in reach. Small and sensitive items are protected reliably by standard securing straps in the shelves and stay this way when the vehicle is in motion.



Hand wash without wet feet:
The spacious and comfortable washroom has a separate shower cubicle with fixed walls and its own standing space in front of the washbasin. The wide, high quality bench toilet is particularly comfortable and easy to clean.



Leak-tight installation:
The shower tray and shower walls are connected to each other through a shell design so that water cannot escape through the joints. Thanks to this leak-tight construction, the use of silicon for sealing purposes was reduced to a minimum.



Toilet emptying made easy:
With its easy to read electronic fill level indicator, the Thetford toilet shows exactly when the black water tank needs to be emptied. The swivel drain point of the tank makes emptying easy and secure, even in tight spaces.

Hymer Exsis-i – Highlights from series production



Well aired, well protected:
Large frosted glass skylights (40 x 40 cm) in the washroom and shower cubicle uphold privacy and allow water vapour and steam to escape quickly. Mosquito nets and blackout blinds are integrated in the flat frame, meaning standing height is not impaired.



Backwall circulation against condensation:
All of the roof storage cupboards have a void at the back through which warm air can circulate unhindered. In this way, high temperature changes in the interior and undesired condensation can be avoided.



Energy-saving LED lights:
The interior lighting throughout the vehicle features LED technology as standard. This saves 3/4 of the energy and increases the service life of the battery by numerous hours. Since LEDs do not become hot, fire and accident safety is also enhanced.



Prepared for radio and TV:
Loudspeakers in the sleeping area and living space, wiring and a socket and also a radio aerial are factory fitted items in every vehicle. All that is needed is for a radio and/or television to be plugged in.

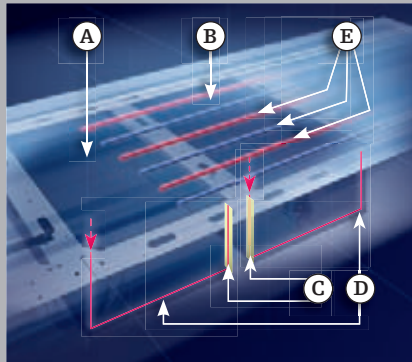

Insulated and heated underbody:
The floor conceals the fresh water (A) and grey water tank (B) in insulated trays (C), which have hot air flowing through them (D). All of the installations (E) are in a heated area of the living space, protected against frost.



Easily accessible drain valves:
The whole supply installation system is designed so that all units are protected in the best way but still have easy access.



Direct access to the tank:
Checking and cleaning the grey water tank is also especially easy and convenient. The cover of the tank is located directly beneath the floor flap and can be accessed with ease from the interior.



Clear route to fresh water:
Likewise in the interior of the vehicle under an additional floor flap is the access point to the fresh water tank. The rotary knob to open and close the overflow has a central location and the large flap is ergonomically formed.



Practical trip switch:
Unlike the central power supply unit, the trip switch is not located in the double floor but in the wardrobe where it can be reached comfortably. In this way, power can be restored quickly should the switch be tripped.

Hymer Exsis-i – Highlights from series production



Vehicle services at a glance:
The fresh water and grey water levels, the battery voltage, the load at the 230 V sockets and additional data readings can be taken from the well laid out control panel above the entry door. This means that the current service levels are always in check.



Plenty of sockets for appliances:
With four 230 volt and two 12 volt sockets, there are numerous means of connection. In the seating group, washroom and kitchen, 230 volt appliances can be connected, while 12 volt devices can be connected at the TV point and in the instrument panel.



Parking for bulky and heavy items:
In the huge rear garage there is plenty of space for bikes placed side-by-side. Even scooters or heavy, bulky items of luggage can be stowed here optimally – up to a maximum permissible load of 250 kilograms.



Double-sided garage access:
The garage features full height doors on both sides of the vehicle as standard. In this way, the garage can be loaded from both sides and luggage remains accessible from the outside at all times.



Safe and secure from outside:
All of the exterior stowage compartments feature sturdy, ergonomic rotary knobs that ensure optimal closing security. The first 180 degree turn closes the door and an additional 180 degree turn presses the door into the frame with a tight and flush fit.



Maximum storage space under the roof:
Throughout the vehicle, a large number of extra deep roof storage cupboards provide plenty of space for holiday clothing, utensils and luggage. Thanks to their sturdy self-supporting design, they are also well suited for heavier items.



Flexibility off the rail:
The high cabinets of the Hymer motorhomes can be adapted to individual requirements thanks to the adjustable shelves (B). One of the shelves features an additional clothing rail (A), which means that garments can be hung up on two levels.

Hymer Exsis-i – Special equipment

For that extra little touch

Give your Exsis-i a touch of your own individual style! Your Hymer trading partner is happy to provide you with details about all of the additional equipment features available for your dream vehicle. A selection of the main extras can be seen on this page.



Individual brightness:

The high quality aluminium rims afford the vehicle additional individuality and class even on the outside. Thanks to its low weight, not only are there payload reserves but the effectiveness of the suspension is increased, thereby improving driving comfort as well.



Relaxed driving:

The Fiat Comfort-Matic combines the precision of a 6-speed gearbox with the comfort of an automatic. Gear changes are either manual, by tipping the selector lever, or fully automatic – with optimised function and consumption.



Highest level of leak-tightness:

The vehicle roof is made from sturdy aluminium and has no longitudinal seams through which water could ingress from above. As additional protection against weather and hailstones, a GFK coating serves to prevent mechanical damage to the surface of the roof.



Well in sight when manoeuvring:

The reversing camera captures the area behind the motorhome and transmits the image in full width to the 7 inch colour monitor in the cab. Its integrated heater guarantees clear view in winter in the event of ice and snow.



Insulated glazing in the cab:

The double glazed windows in the driver door and on the co-driver side provide additional thermal protection if required. They also prevent water running off the windows into the interior in the event of high condensation and they reduce driving noise.



Darkness at the press of a button:

The electric roller blinds of the windscreen darken the cab area in a pleasant way. As an additional guard against cold and direct sunlight it also contributes towards a cosy atmosphere all year round



High tech in the kitchen:
The tall TEC-Tower is a superlative item of modern kitchen equipment in the motorhome. It comprises a fridge freezer unit (160 litres), an oven and a grill in a timeless classy design and impresses not only in terms of looks but also as a versatile helper.



Lots of space for fresh food:
The large refrigerator is part of the standard equipment. With a capacity of 150 litres and a separate freezer compartment, it keeps even large quantities of groceries fresh with ease.



Clear view to the sky:
The optional skylight (40 x 40 cm) above the drop-down bed means that sleepers can be gently woken by the sun in the morning. As with all other skylights, a mosquito net and blackout blind is also integrated here with a clever space saving design.



Electric drop-down bed:
The 1.50 metre wide drop-down bed above the cab can be raised and lowered electrically with no effort whatsoever. The switch for the jolt-free electric drive is integrated on the front of the bed and can be reached from the living space with ease.

Hymer Exsis-i – Interior design

As individual as you yourself

Combine your own choice of furniture finish – “Trentino pearwood” or “Umbria Select” – as you like it with one of ten high quality fabric designs. Giving the interior of your Hymer Exsis-i your own personal touch is that easy.



“Salerno” fabric design
(material: textile)



“Husum” fabric design
(material: textile)



“Charbonnel” fabric design
(material: textile)



“Castello” fabric design
(material: textile)



“Barodino” fabric design
(material: textile)

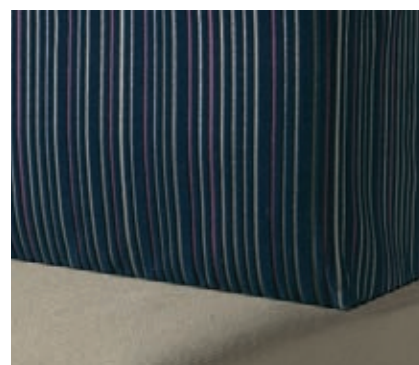

“Viola” fabric design
(material: textile)





"Göteborg" fabric design
(material: textile)



"Bolton" fabric design
(material: leather/textile)



"Trinidad" fabric design
(material: leather/textile)



"Caramel leather" fabric design
(material: leather)



"Havanna" carpet
(section: cab and living space)



"Avalon" carpet
(section: cab and living space)



Hymer Exsis-i





Compact: Exsis-i 504
with sleeping comfort for three people.

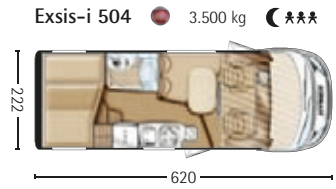

Flexible: Exsis-i 578
with comfortable single beds.

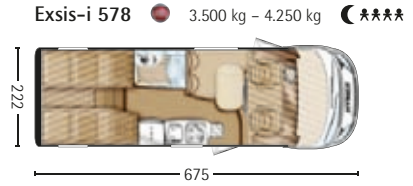

Open plan: Exsis-i 614
with rear lateral bed
and additional seating space.

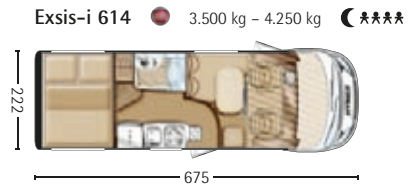

Space for six: Exsis-i 644
sleeps up to 6 with opposing seating group.

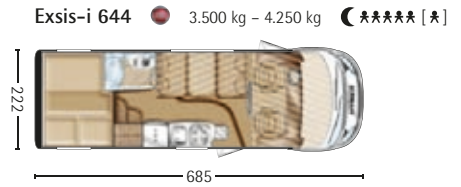

Extended: Exsis-i 674
with single beds and large wardrobe.

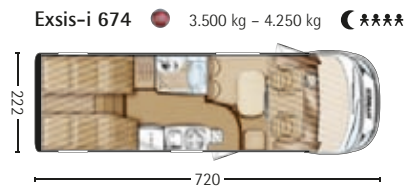

Spacious: Exsis-i 678
with extra-large comfort washroom.

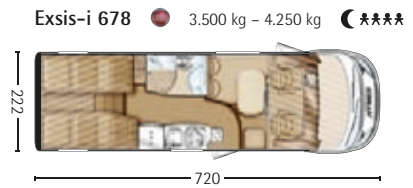

Generous: Exsis-i 698
with queen-size bed, accessible
from three sides.

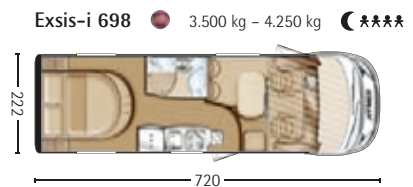

Hymer Exsis-i – Floor layouts

Welcome to the 3 ton class

Sweden

Hymer – Land of discovery



Discover Sweden's diversity. Unforgettable experience with nature.
Enjoy the most glorious routes with Hymer. Information all about "camping land" Sweden.

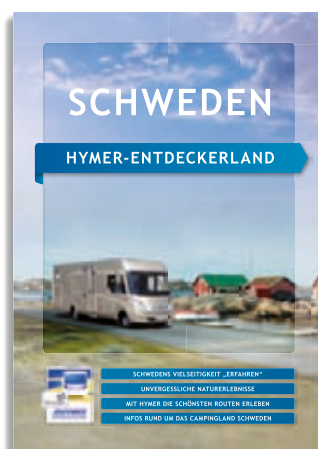

Find out more at: www.hymer.com/entdeckerlandschweden

Note:

This brochure describes the series status at the time of publication. Some of the photos contain optional extras. Despite careful checking of the contents, printing errors are not excluded. During the course of the model year, we reserve the right to make changes to equipment or product improvements. Before entering into a sales contract, please find out from our authorised Hymer dealership about the current product and model status.

In some cases, the vehicles are illustrated with optional extras that are contained in the valid price list and for which additional payment is required. The decorations illustrated are not part of the Hymer scope of supply. The specifications concerning the scope of supply, appearance, performance, dimensions and weights of the vehicles – dimensions within the scope of factory tolerances (max +/- 5%) are possible and permitted – correspond to the state of knowledge valid at the time of printing. They comply with European homologation regulations; these regulations may change up to the time of vehicle purchase or up to the time of delivery. Your Hymer dealer will be delighted to inform you of any changes and about the standard scope of supply.

Copyright by HYMER AG.

The water supply system meets
the currentstate of the art as at 07/2011
(EC Directive 2002/72/EC).

The logo for Hymer AG, featuring the word "HYMER" in a bold, blue, sans-serif font. The letter "H" is stylized with three horizontal bars extending to the left.

HYMER AKTIENGESELLSCHAFT
Postfach 1140
88330 Bad Waldsee
www.hymer.com

www.facebook.com/hymerAG